

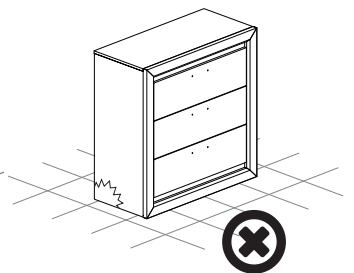

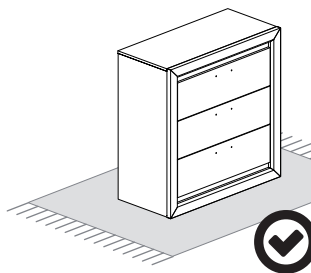

OPTIMAL 28

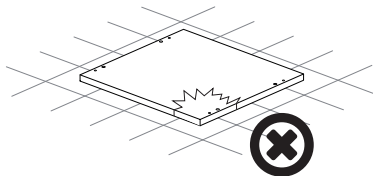

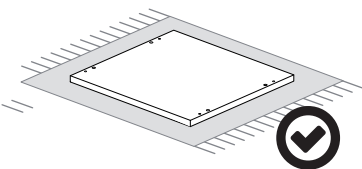
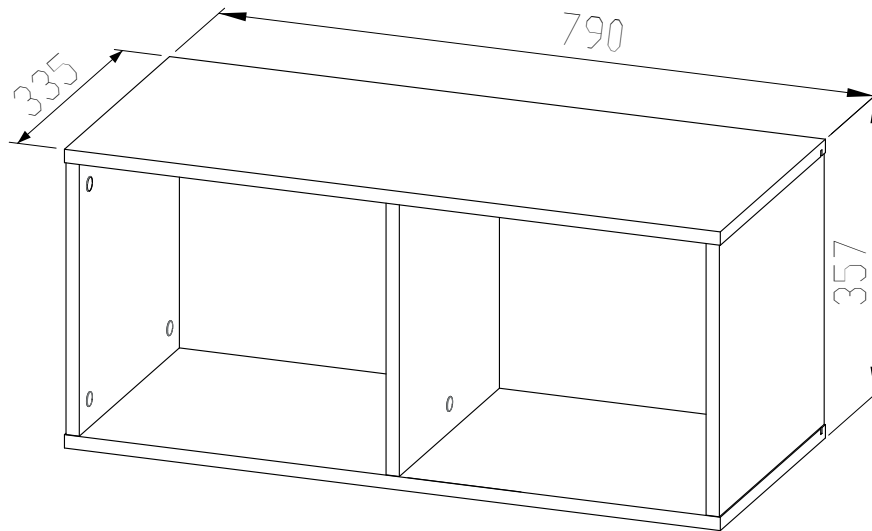
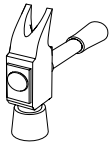
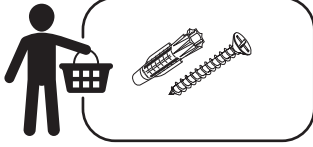
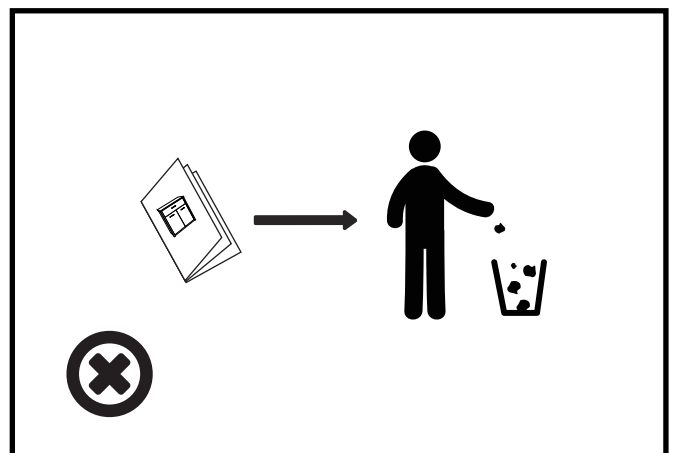
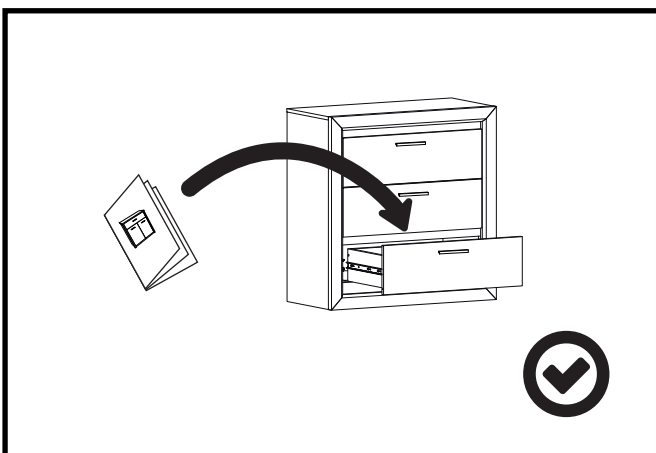
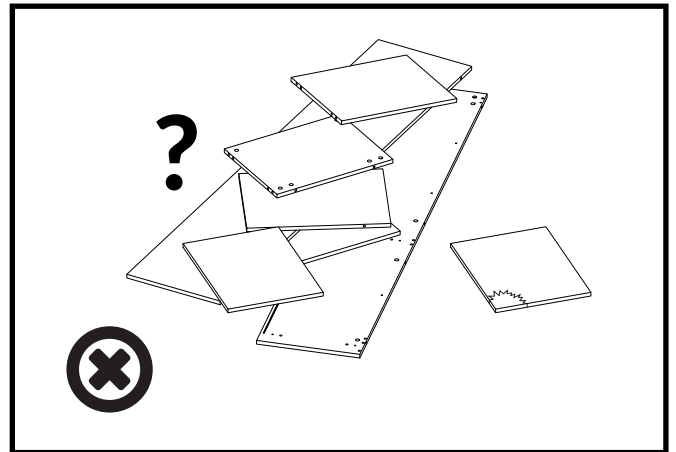
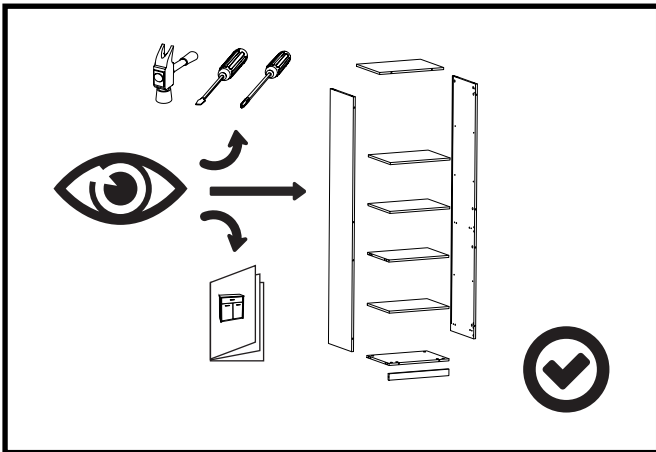
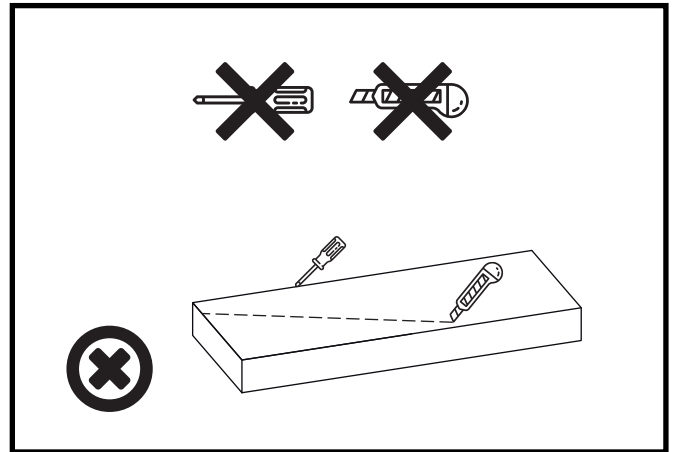
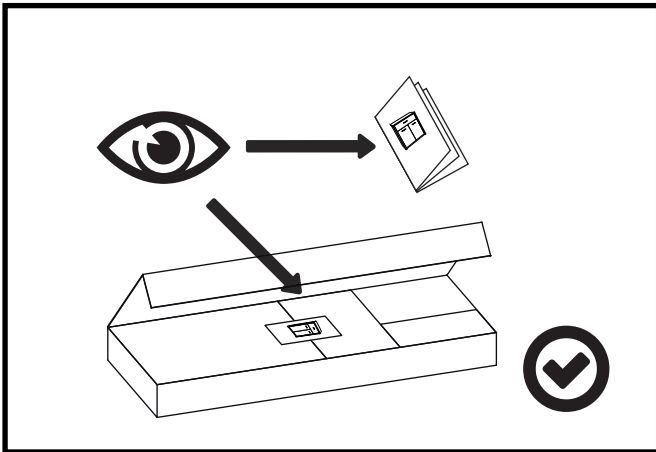
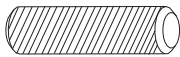

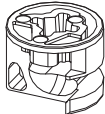

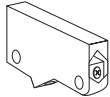
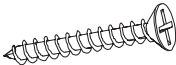
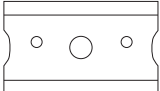
OPTIMAL 28

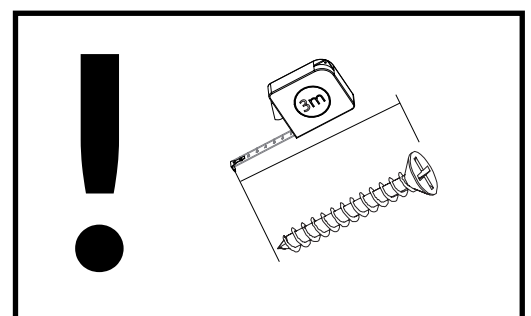
K1 x 12 	GW1 x 5 	B2 x 10 
ZS2 x 10 	ZJ1 x 10 	ZW3 x 2 
WT18 x 4 4x30 	LM x 2 	

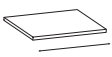

OPTIMAL 28

			
①	325	319	1
②	325	334	1
③	325	334	1
④	790	335	1
⑤	790	335	1
⑥	765	335	1

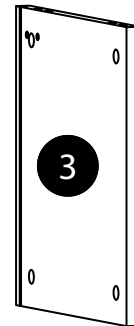
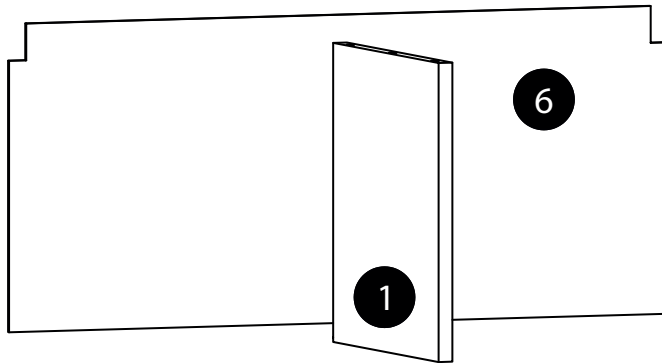
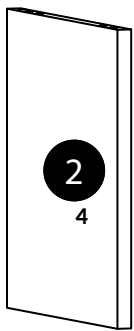
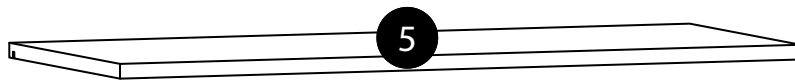

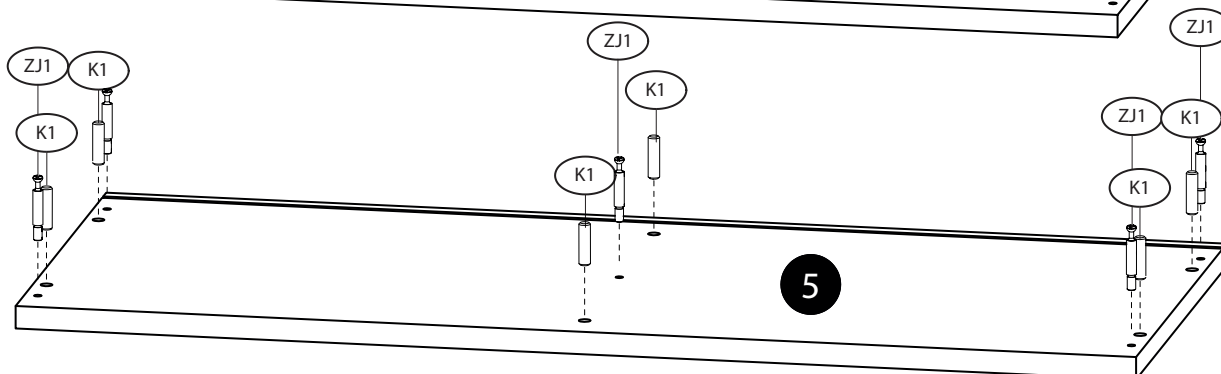
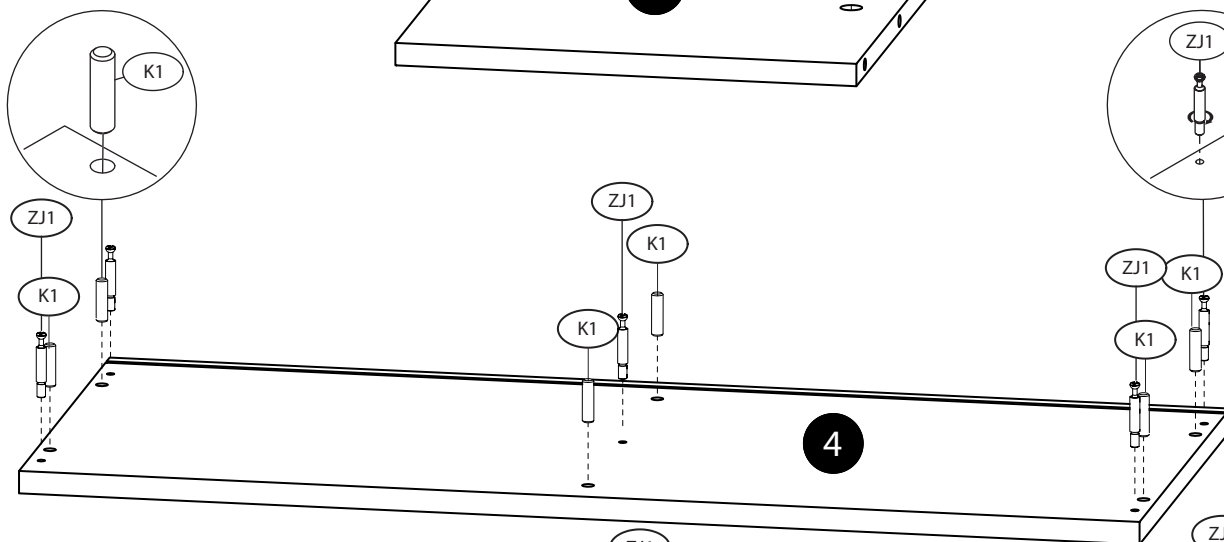
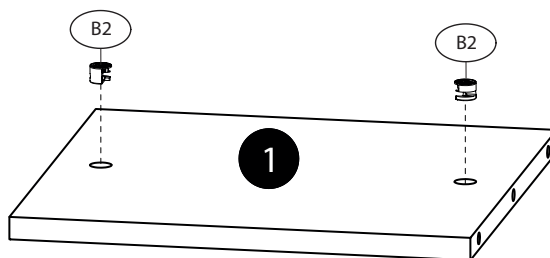
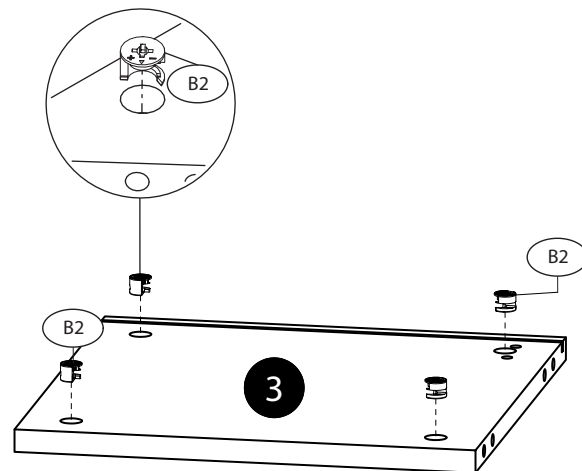
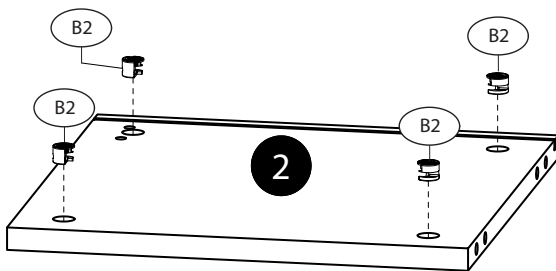
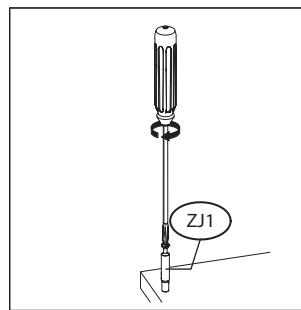
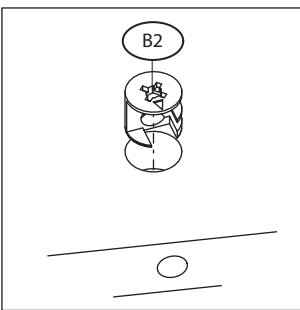
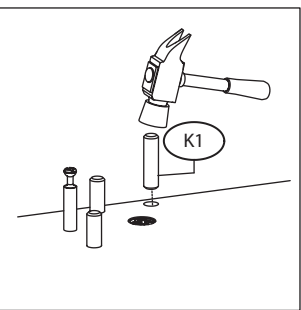

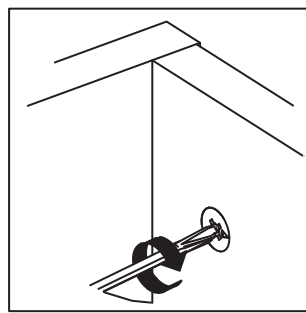
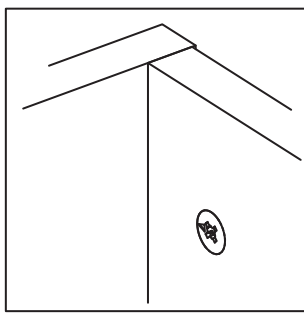
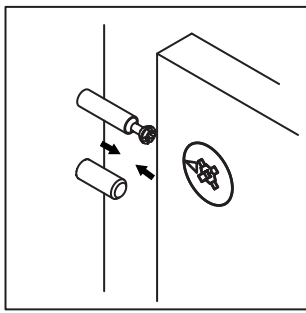

A ▶

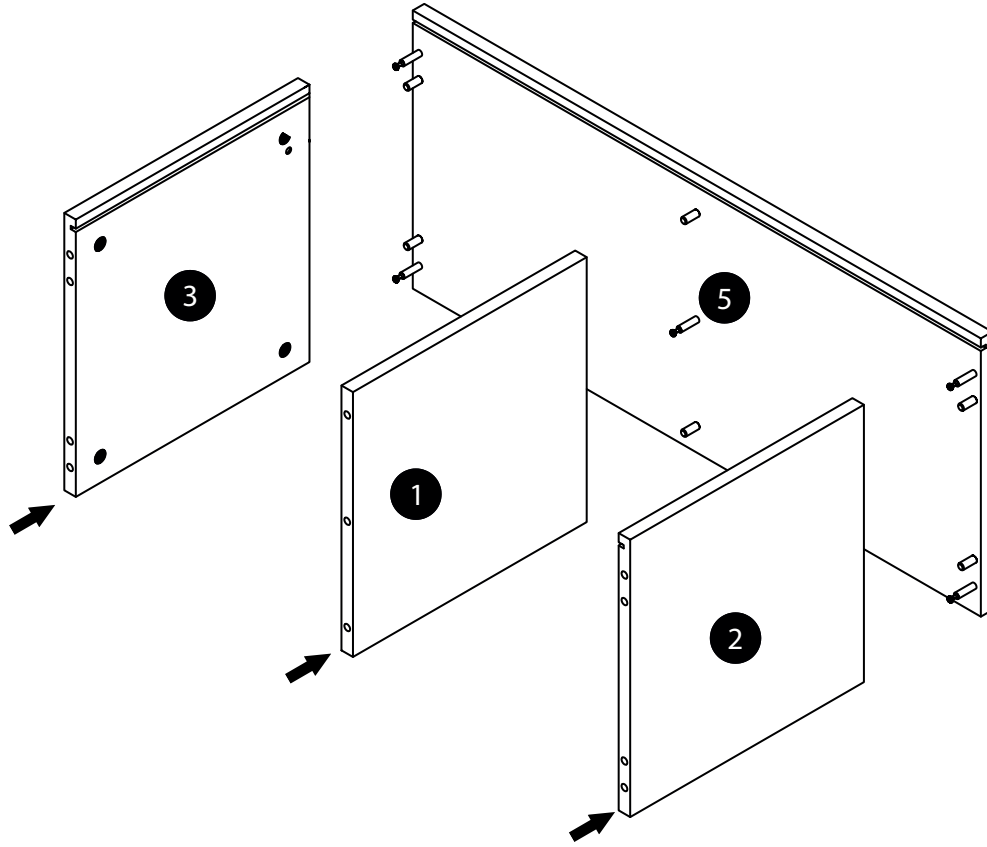

B ▶

